

Product Description

MECGaNTRSX is a 0.25 μ m GaN HEMT Transmit/Receive Switch designed and tested by MEC for X-Band applications.

In the frequency range from 8 GHz to 11.5 GHz *MECGaNTRSX* provides less than 1.1 dB of small signal insertion loss, more than 28 dB of isolation, and less than 1.5 dB of insertion loss at 40 dBm of input power in transmit mode.

The Tx input port of the *MECGaNTRSX* is Absorptive.

Main Features

- 0.25 μ m GaN HEMT Technology
- 8– 11.5 GHz full performance Frequency Range
- Rx Small Signal Insertion Loss < 1.1 dB
- Tx Small Signal Insertion Loss < 1 dB
- Tx P1dB = 43 dBm
- Tx Insertion Loss @ Pin=40 dBm < 1.5 dB
- Input Power Handling = 46 dBm
- Isolation Tx-Rx > 28 dB
- Return Loss > 12 dB
- Tx absorptive port
- Rx reflective port
- Control Voltage: Vc = 0/ -30V
- Chip Size: 3.00 x 1.00 x 0.10 mm³

Typical Applications

- Commercial and Military Radar
- Communications
- Test Instrumentation

Measured Data

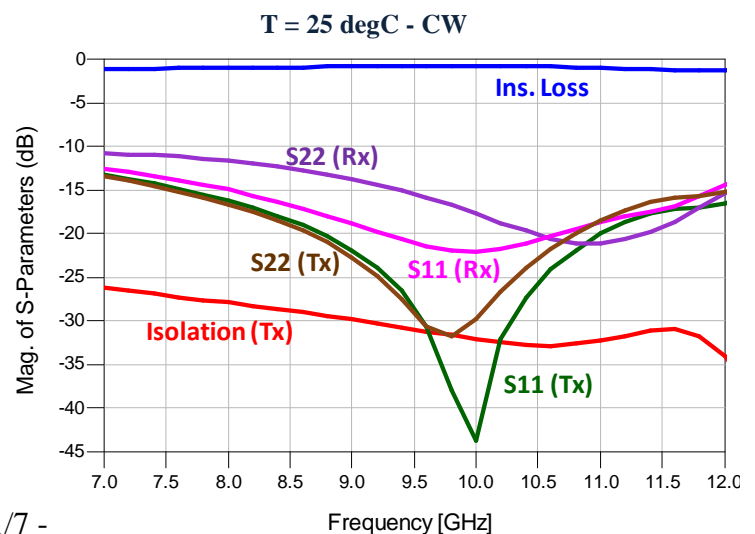

1/7 -

Main Characteristics - Rx Mode

Test Conditions: $T_{\text{base_plate}} = 25^{\circ}\text{C}$ ($V_{c1} = -30\text{ V}$, $V_{c2} = -0\text{ V}$) - CW

Parameter	Min	Typ	Max	Unit
Operating frequency	8		11.5	GHz
Small Signal Insertion Loss	0.8		1.1	dB
Isolation Tx-Rx	20		35	dB
Input Return Loss (Ant)	15		22	dB
Output Return Loss (Rx)	12		21	dB
Return Loss @ Tx port (Absorptive)	5		15	dB
Gate Control Voltage V_{c1}	-30		-25	V
Gate Control Voltage V_{c2}	0		1	V
Control Current			0.5	mA

Main Characteristics - Tx Mode

Test Conditions: $T_{\text{base_plate}} = 25^{\circ}\text{C}$ ($V_{c1} = 0\text{ V}$, $V_{c2} = -30\text{ V}$) - Pulsed

Parameter	Min	Typ	Max	Unit
Operating frequency	8		11.5	GHz
Small Signal Insertion Loss	0.8		1	dB
Isolation Tx-Rx	28		33	dB
Input Return Loss (Tx)	17		40	dB
Output Return Loss (Ant)	17		32	dB
Return Loss @ Rx port (Reflective)		4		dB
Pin - 1 dB		43		dBm
Insertion Loss @ Pin=40 dBm		1.3		dB
Input Power Handling		46		dBm
Gate Control Voltage V_{c1}	0		1	V
Gate Control Voltage V_{c2}	-30		-25	V
Control Current			0.5	mA

Receive Mode: Insertion Loss, Isolation and Return Loss

Test Conditions: $T_{\text{base_plate}} = 25^{\circ}\text{C}$, $V_{c1} = -30\text{ V}$, $V_{c2} = 0\text{ V}$ - CW

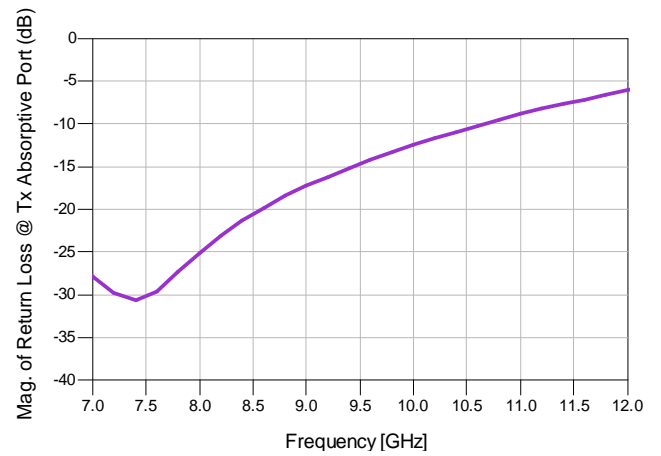
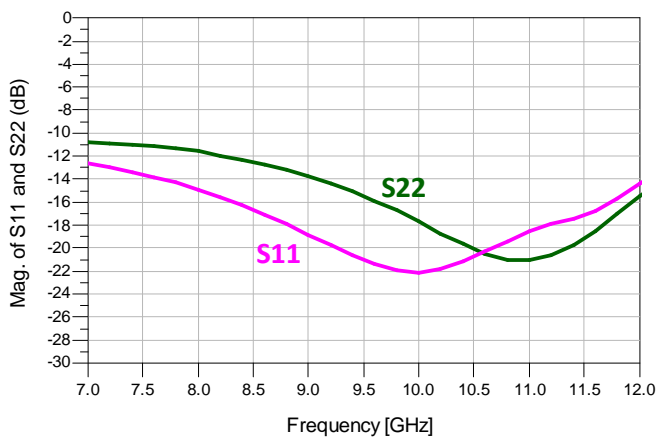
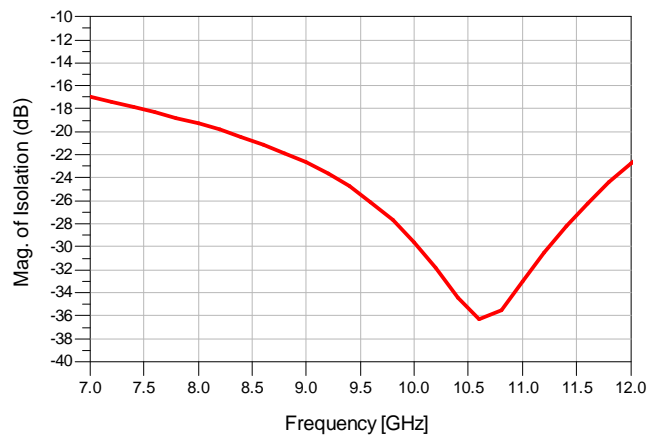
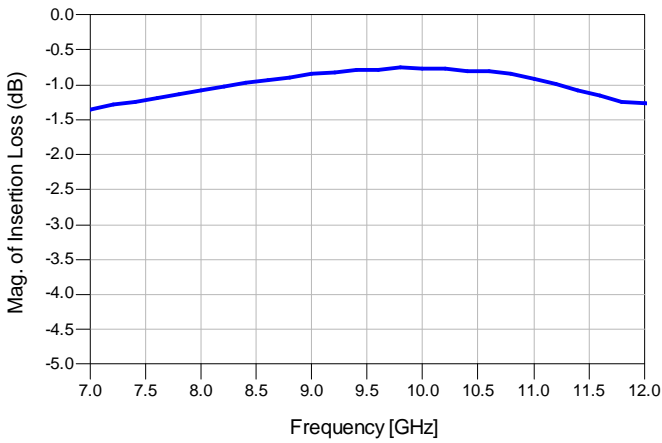

Transmit Mode: Insertion Loss, Isolation and Return Loss

Test Conditions: $T_{\text{base_plate}} = 25^{\circ}\text{C}$, $V_{c1} = 0\text{ V}$, $V_{c2} = -30\text{ V}$ - CW

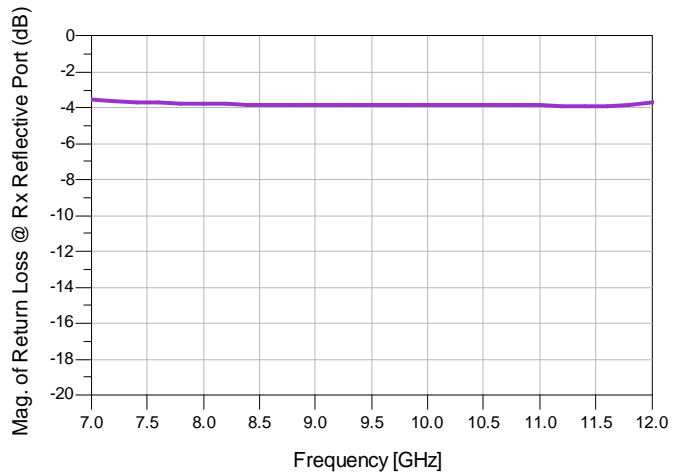
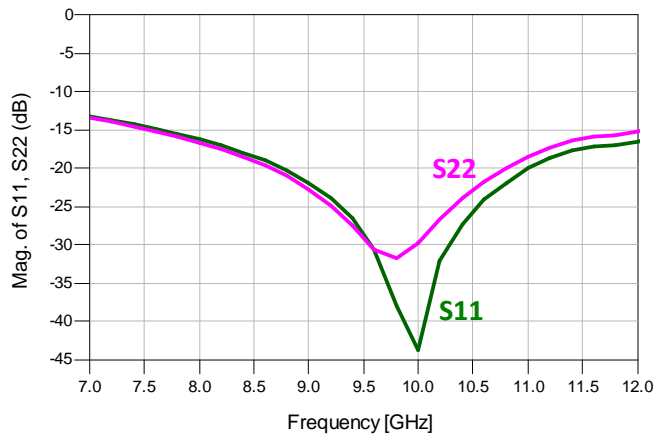
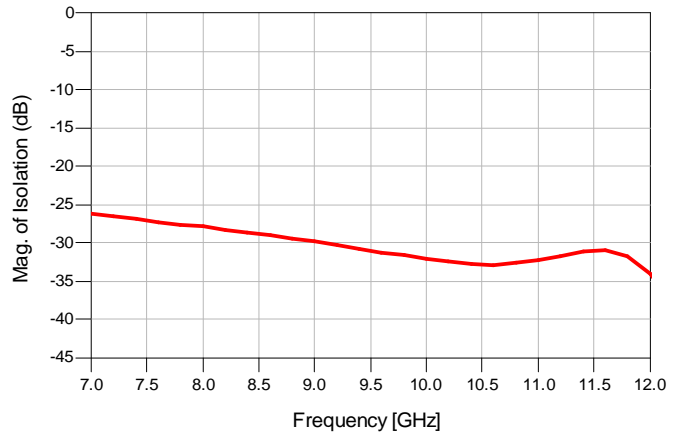
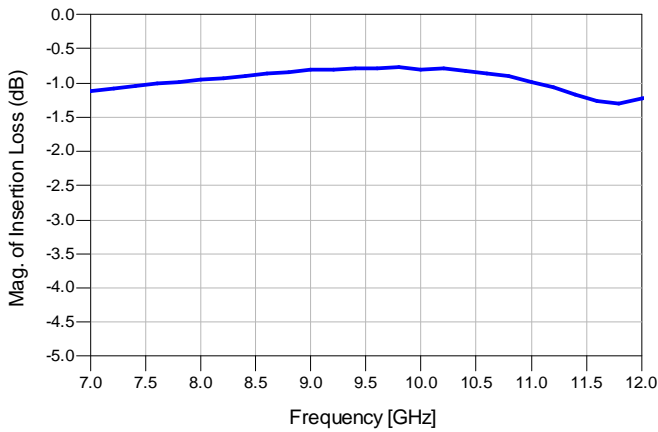

Transmit Mode Nonlinear Measurement: Insertion Loss

Test Conditions: $T_{\text{base_plate}} = 25^{\circ}\text{C}$, $V_{c1} = 0\text{ V}$, $V_{c2} = -30\text{ V}$ - Pulsed

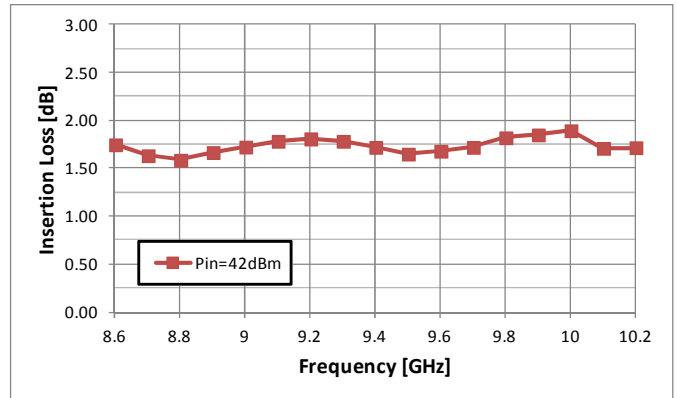
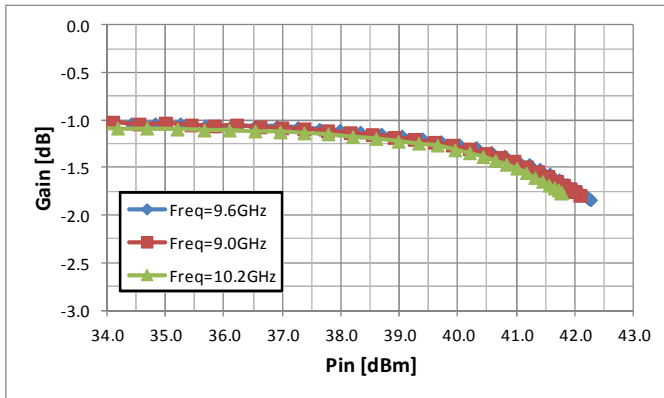

Function Table

RF path	State	Vc1	Vc2
Antenna to Rx	Receive	-30 V	0 V
Tx to Antenna	Transmit	0 V	-30 V

Bond Pad Configuration & Assembly Recommendations

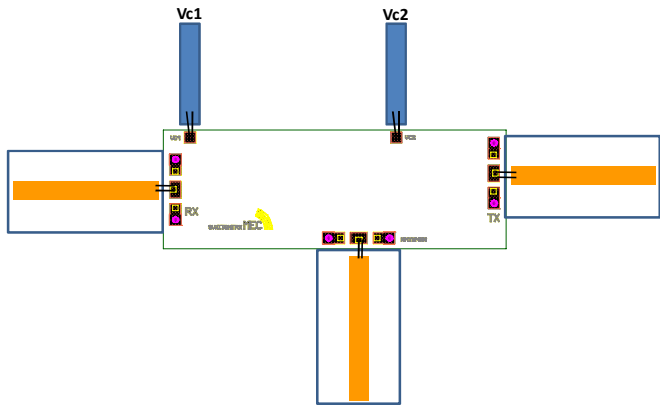

Bond Pad #	Connection	External Components
Rx, Tx and Antenna	2 Bonding Wires $L_{bond} = 0.3nH$	
Vc1, Vc2	$L_{bond} \leq 1 nH$	No external components required (Internal Series Resistance: $R_s=4k\Omega$)

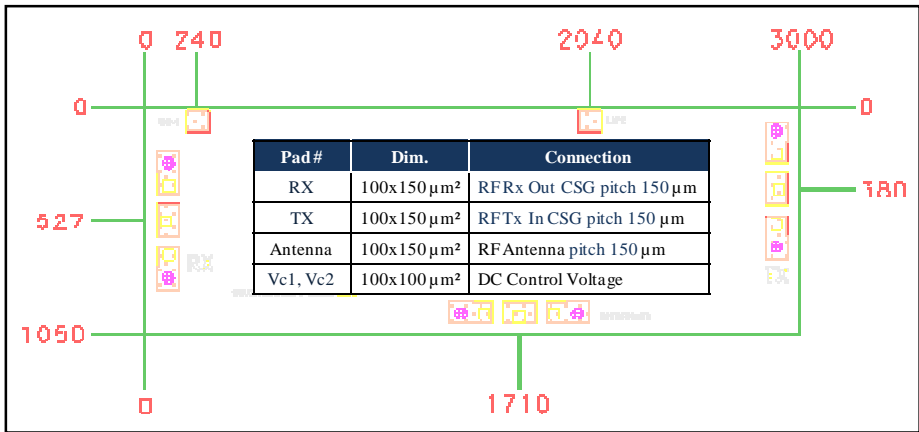

Eutectic Die bond using AuSn (80/20) solder is recommended.

The backside of the die is the Source (ground) contact.

Thermosonic ball or wedge bonding are the preferred connection methods.

Gold wire must be used for connections.

Bias Procedure

Bias-Up

1. Vc1 and Vc2 sets to Control Voltage.
2. Apply RF signal.

Bias-Down

1. Turn off RF signal.
2. Turn off Vc1, Vc2.

MECGaNTRSX

X-Band GaN HEMT TxRx Absorptive Switch



Contact Information

For additional technical Information and Requirements:

Email: contact.mec@mec-mmic.com

Tel: +39 0516333403

For sales Information and Requirements:

Email: sales@mec-mmic.com

Tel: +39 0637511124

Notice

The furnished information is believed to be reliable. However, performances and specifications contained herein are based on preliminary characterizations and then susceptible to possible variations. On the basis of customer requirements the product can be tested and characterized in specific operating conditions and, if needed, tuned to meet custom specifications.

The contents of this document are under the copyright of MEC srl. It is released by MEC srl on condition that it shall not be copied in whole, in part or otherwise reproduced (whether by photographic, reprographic, or any other method) and the contents thereof shall not be divulged to any person other than inside the company at which has been provided by MEC.