

### Product Description

*MECGaNSCTRMX* is a 0.25 $\mu$ m GaN based MMIC integrating the main functions of an X-Band T/R Module Frontend: HPA, TR Switch and LNA.

Referring to the present X-band T/R module, *MECGaNSCTRMX* allows a size reduction of about 40% keeping the same output power level ( $\approx$  39 dBm).

The *MECGaNSCTRMX* MMIC also has a competitive noise performance in receiving mode ( $\approx$  2.5 dB) because it allows for limiter elimination in the receiver frontend.

During receiving phase it is capable of working in safe operation up to 26 dBm of CW overdrive power; in addition, the high isolation provided by the Switch when receiving path is disconnected allows to handle up to 40 dBm with LNA in Standby mode.

### Main Features

- 0.25 $\mu$ m GaN HEMT Technology
- 8.6 – 11.2 GHz full performance Frequency Range
- Chip Size: 3.0 x 3.0 x 0.10 mm<sup>3</sup>

#### Tx chain (pulsed)

- Gain: 22 dB
- Psat: 39 dBm
- PAE: 25%
- Bias: Vd = 30V, Idq = 280mA, Vg = -2.9V (Typ.)

#### Rx chain (CW)

- Gain: 15 dB
- NF: < 3.0 dB (2.5 dB midband)
- P1dB: 22 dBm
- Psat: 26 dBm
- Pin\_Max: 26 dBm
- Bias: Vd = 10 V, Idq = 80 mA, Vg = -2.8V (Typ.)

### Typical Applications

- Commercial and Military Radar

### Functional Blocks

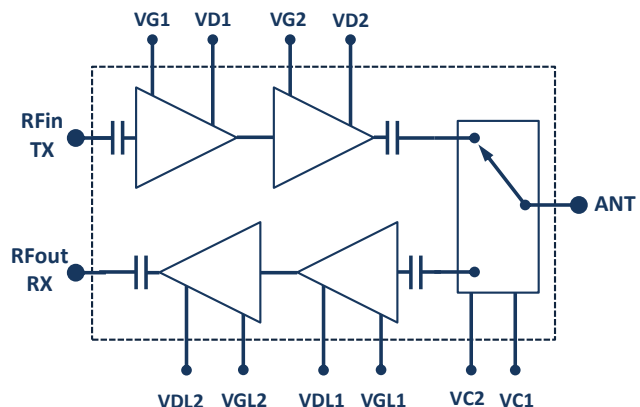

### Main Characteristics - Tx Mode

Test Conditions:  $T_{\text{base\_plate}} = 25^{\circ}\text{C}$  ,  $V_d = 30\text{ V}$  ,  $I_{dq} = 280\text{ mA}$  - Pulsed:  $330\mu\text{s}$  - 10%

Parameter	Min	Typ	Max	Unit
Operating frequency	8.6		11.2	GHz
Small Signal Gain	22.5		25.5	dB
Input Return Loss			-8	dB
Output Return Loss			-10	dB
Output Power at PAE max. (Pin=23 dBm)		38		dBm
Output Power at Saturation (Pin = 26 dBm)		39		dBm
PAE max. (Pin=23 dBm)		26		%
PAE at Saturation (Pin = 26 dBm)		24		%
Isolation ANT-Rx		40		dB
Drain Supply Voltage		30		V
Supply Quiescent Drain Current		0.28		A
Supply Drain Current at PAE max. (Pin=23 dBm)		0.9		A
Supply Drain Current at Saturation (Pin = 26 dBm)		1.0		A

### Main Characteristics - Rx Mode

Test Conditions:  $T_{\text{base\_plate}} = 25^{\circ}\text{C}$  ,  $V_d = 10\text{ V}$  ,  $I_{dq} = 80\text{ mA}$  - CW

Parameter	Min	Typ	Max	Unit
Operating frequency	8.6		11.2	GHz
Small Signal Gain	15		16	dB
Noise Figure	2.5		3.0	dB
Input Return Loss		-20	-12	dB
Output Return Loss		-15	-10	dB
Output Power at 1 dB of Gain Compression (Pin=8 dBm)		22		dBm
Output Power at Saturation (Pin=17 dBm)	25		26	dBm
Overdrive Input Power (CW)			26	dBm
Overdrive Gain Compression Level			15	dB
Drain Supply Voltage		10		V
Supply Quiescent Drain Current		80		mA
DC Power Consumption		0.8		W
DC Power Consumption at 1 dB of Gain Compr.			1	W

Control Voltages		
VC1 = 0V	VC2 = -30V	Tx Mode
VC1 = -30V	VC2 = 0V	Rx Mode

### Typical Performance - Tx Mode

Test Conditions:  $T_{base\_plate} = 25^{\circ}C$ ,  $V_d = 30V$ ,  $I_{dq} = 280mA$  - Pulsed:  $330\mu s - 10\%$  - Control:  $VC1=0V$ ,  $VC2=-30V$

S-Parameters Vs. Frequency

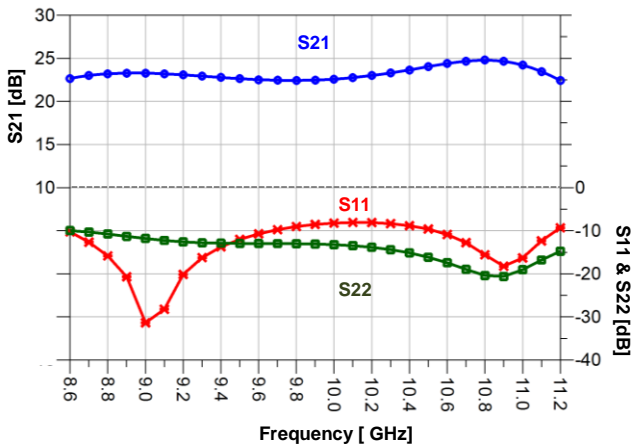

Isolation Antenna – RFout at Rx during Tx mode at three different Bias conditions of the LNA

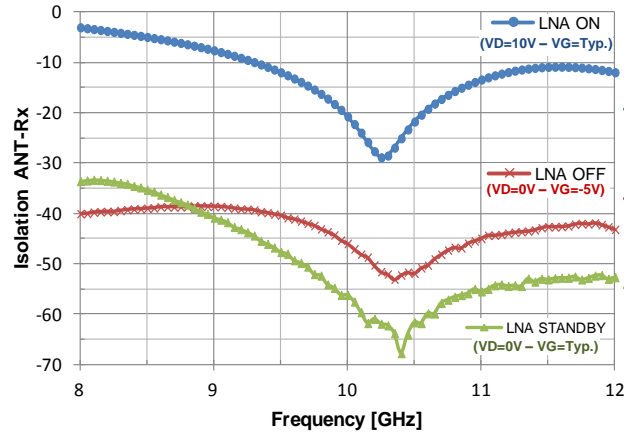

Pout and PAE Vs. Pin @ 8.6 GHz

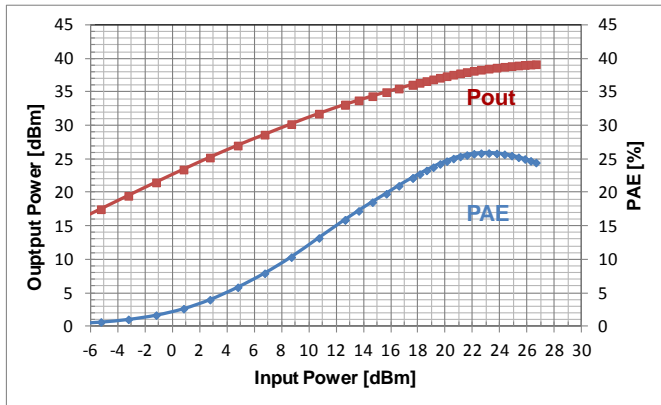

Gain and Id Vs. Pin @ 8.6 GHz

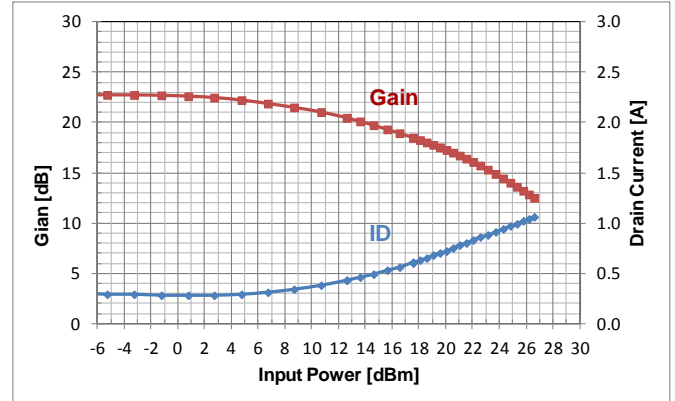

Pout and PAE Vs. Pin @ 9.4 GHz

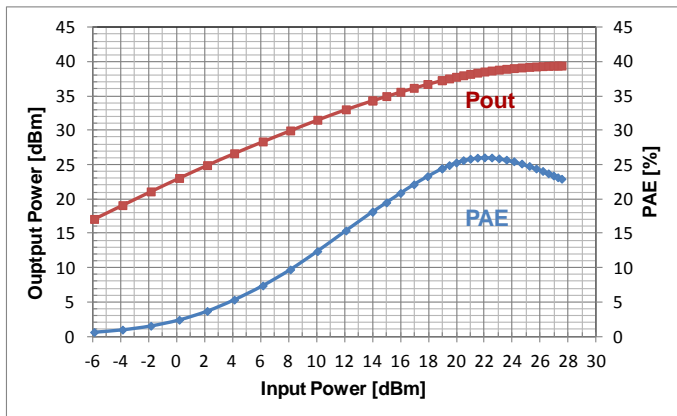

Gain and Id Vs. Pin @ 9.4 GHz

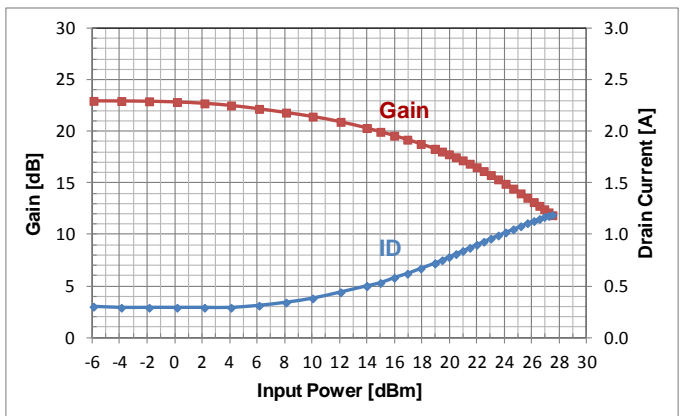

### Typical Performance - Tx Mode

Test Conditions:  $T_{\text{base\_plate}} = 25^{\circ}\text{C}$ ,  $V_d = 30\text{ V}$ ,  $I_{dq} = 280\text{ mA}$  - Pulsed:  $330\mu\text{s} - 10\%$  - Control:  $VC1=0\text{V}$ ,  $VC2=-25\text{V}$

Pout and PAE Vs. Pin @ 10.0 GHz

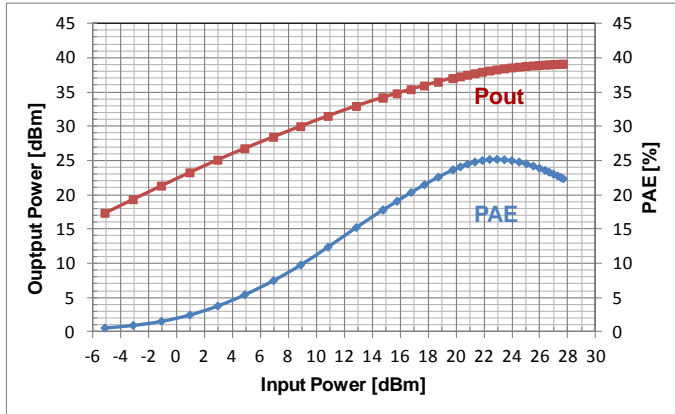

Gain and Id Vs. Pin @ 10.0 GHz

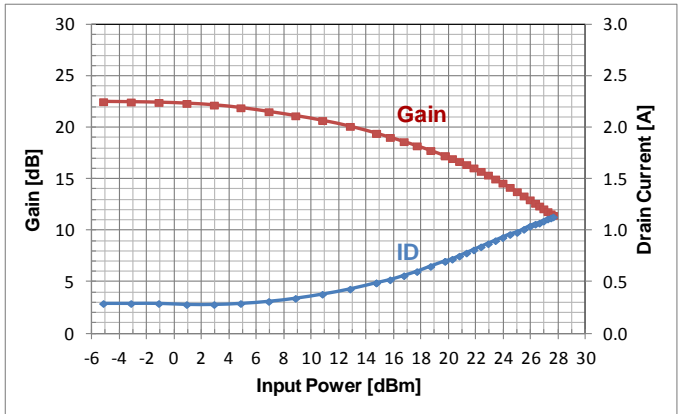

Pout and PAE Vs. Pin @ 10.6 GHz

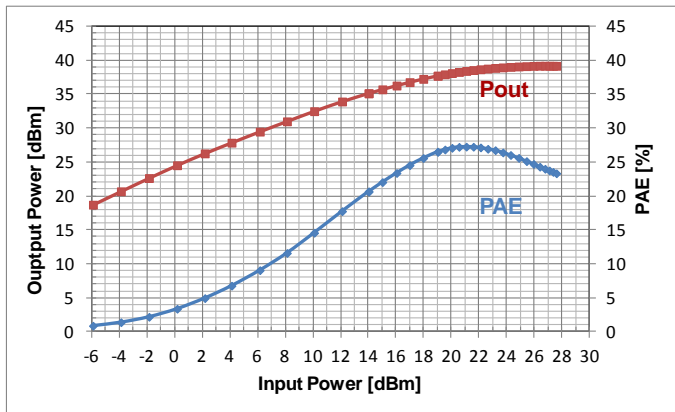

Gain and Id Vs. Pin @ 10.6 GHz

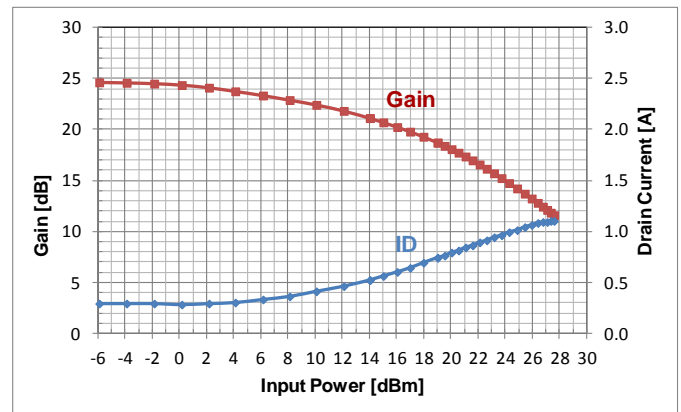

Pout and PAE Vs. Pin @ 11.2 GHz

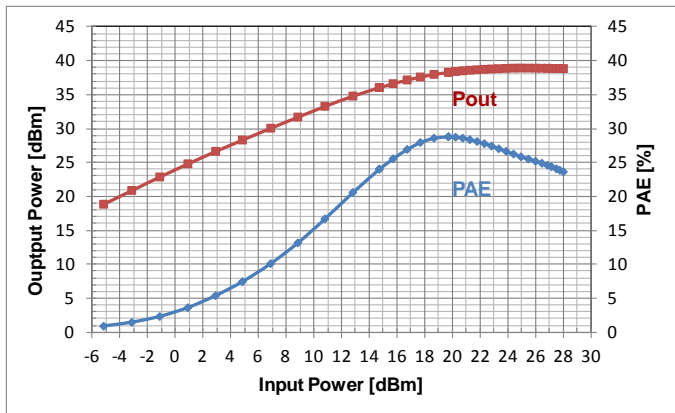

Gain and Id Vs. Pin @ 11.2 GHz

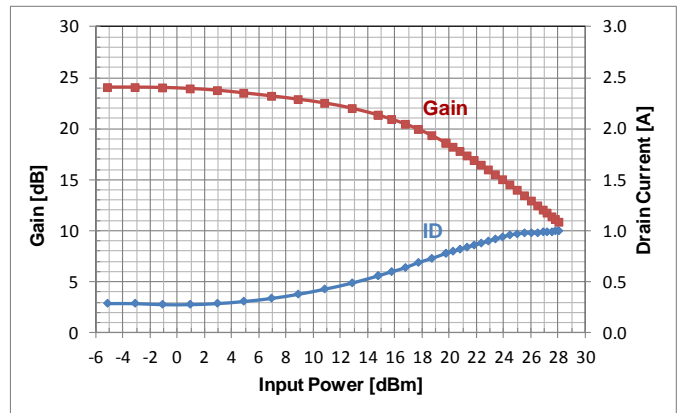

### Typical Performance - Tx Mode

Test Conditions:  $T_{base\_plate} = 25^{\circ}C$ ,  $V_d = 30V$ ,  $I_{dq} = 280mA$  - Pulsed:  $330\mu s - 10\%$  - Control:  $VC1=0V$ ,  $VC2=-30V$

Pout and PAE Vs. Frequency @ PAEmax

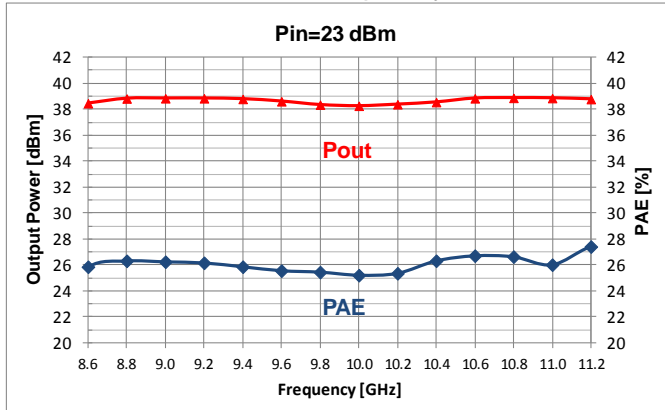

Gain and Id Vs. Frequency @ PAEmax

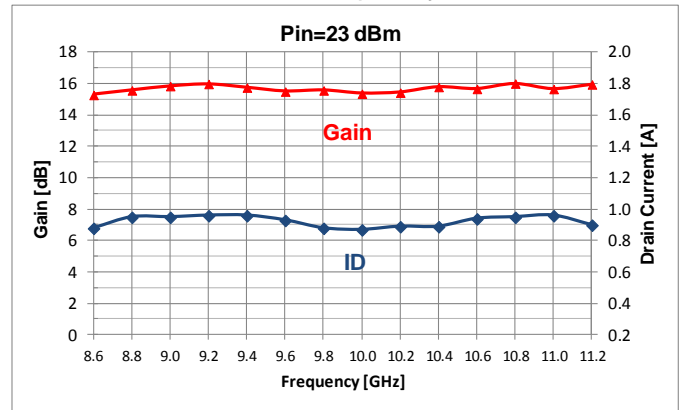

Pout and PAE Vs. Frequency @ Saturation

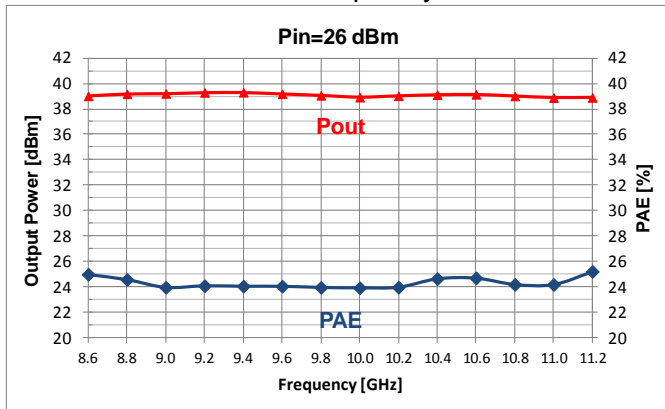

Gain and Id Vs. Frequency @ Saturation

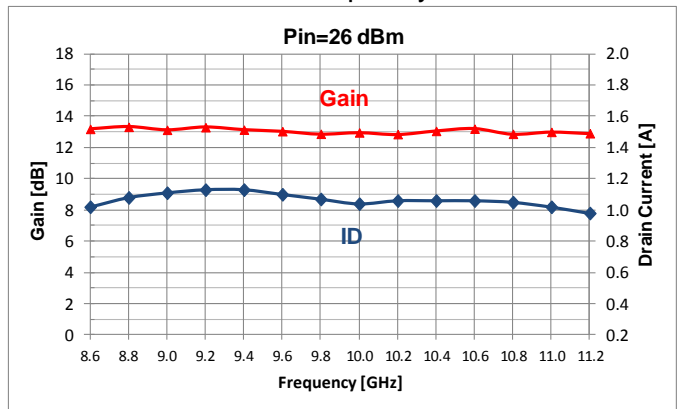

Pout Vs. Compression

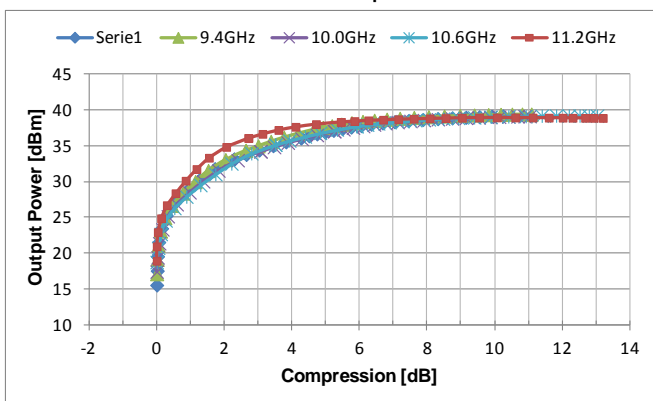

Compression Vs. Frequency @ Saturation and PAEmax

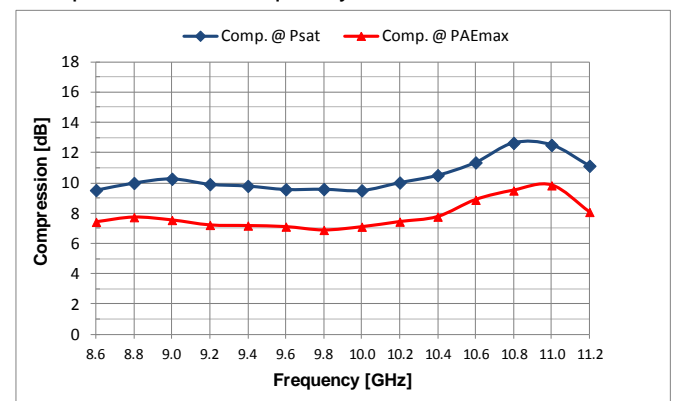

### Typical Performance - Rx Mode

Test Conditions:  $T_{base\_plate} = 25^{\circ}C$ ,  $V_d = 10 V$ ,  $I_{dq} = 80 mA$  - CW - Control:  $VC1 = -30V$ ,  $VC2 = 0V$

S-Parameters and Noise Figure Vs. Frequency

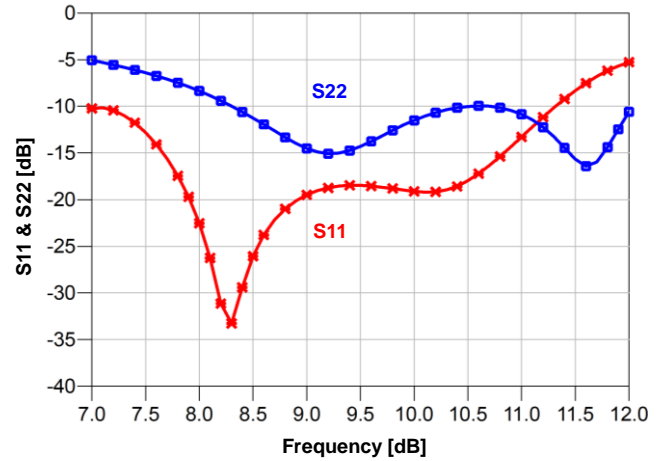
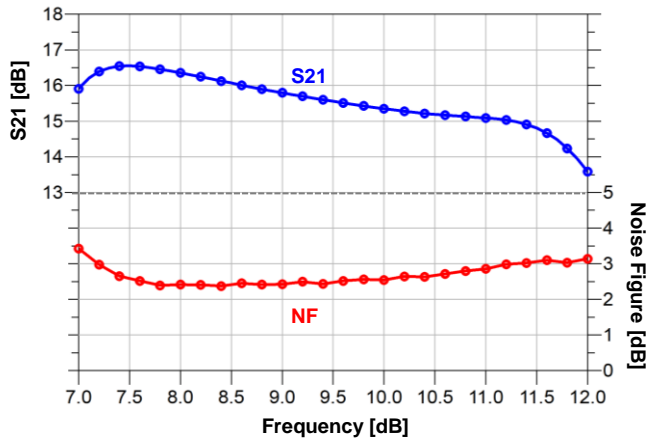

Pout and Gain Vs. Pin @ 8.6 GHz

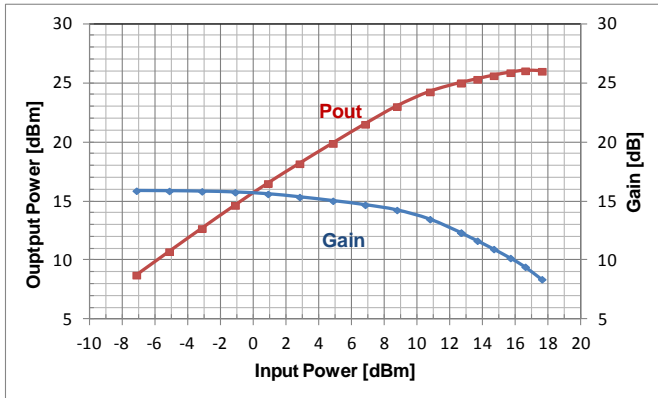

Pout and Gain Vs. Pin @ 9.4 GHz

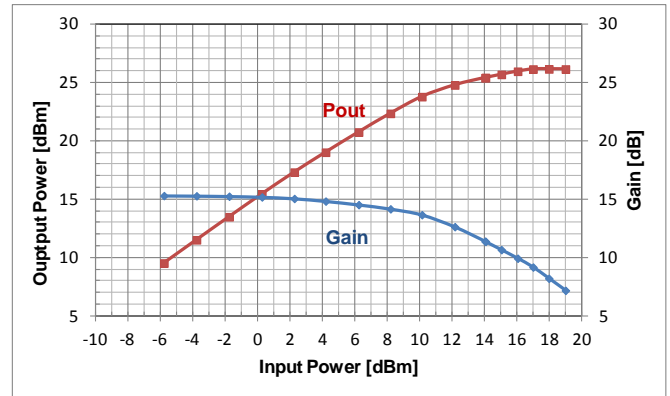

Pout and Gain Vs. Pin @ 10.6 GHz

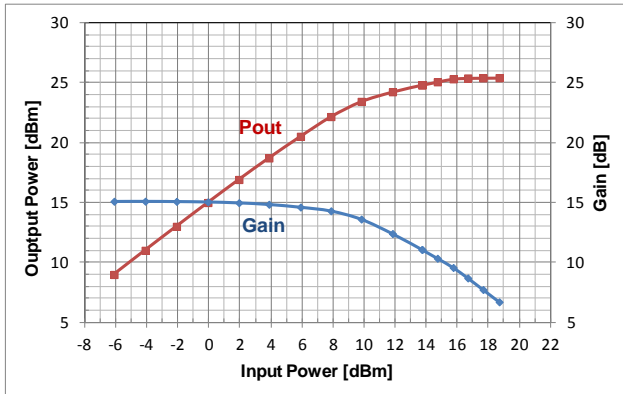

Pout and Gain Vs. Pin @ 11.2 GHz

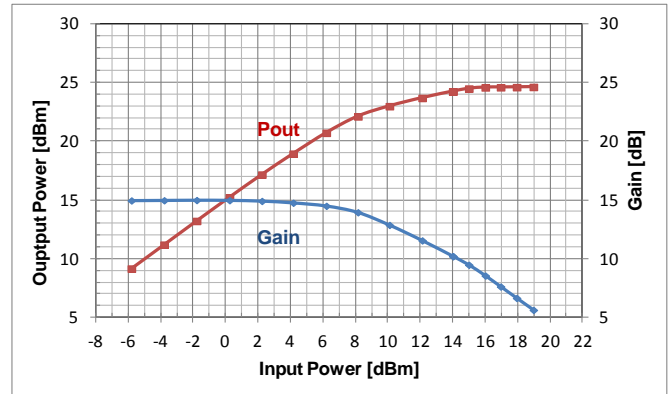

### Typical Performance - Rx Mode

Test Conditions:  $T_{base\_plate} = 25^{\circ}\text{C}$ ,  $V_d = 10\text{ V}$ ,  $I_{dq} = 80\text{ mA}$  - CW - Control:  $VC1 = -30\text{V}$ ,  $VC2 = 0\text{V}$

Pout and Gain Vs. Frequency @ P1dB  
( $P_{in} = 8\text{dBm}$ )

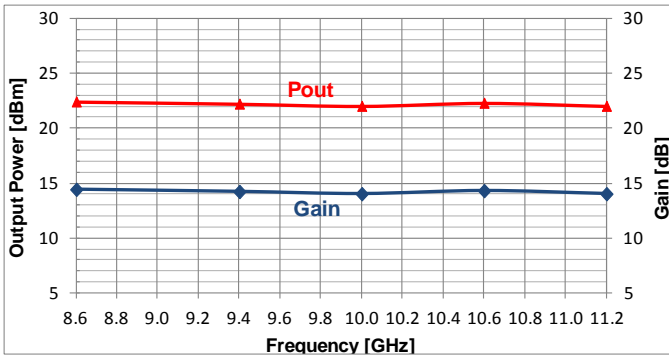

Pout and Gain Vs. Frequency @ Saturation  
( $P_{in} = 17\text{dBm}$ )

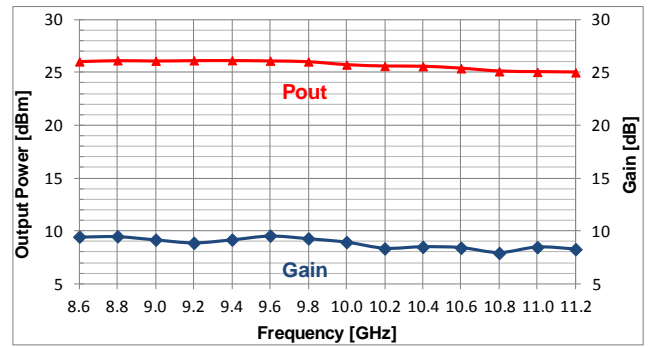



### Bond Pad Configuration & Assembly Recommendations

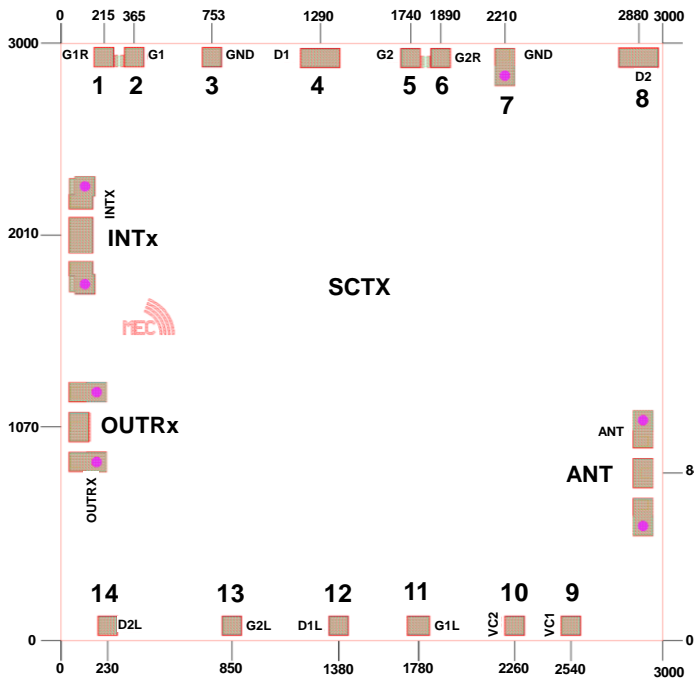

- A tolerance of  $\pm 35\mu\text{m}$  has to be considered for chip dimensions
- Chip Thickness is  $70\mu\text{m} \pm 10\mu\text{m}$
- RF Pads=  $100\mu\text{m} \times 150\mu\text{m}$
- DC Pads=  $100\mu\text{m} \times 100\mu\text{m}$
- DC Pad (4,8)=  $200\mu\text{m} \times 100\mu\text{m}$

Bond Pad #	Symbol	Description
INTx	INTx	Tx-Mode Input RF Port
ANT	ANT	Tx-Mode Output RF Port Rx-Mode Input RF Port
OUTRx	OUTRx	Rx-Mode Output RF Port
2,5	G1, G2	HPA - Gate Supply Voltage
4,8	D1, D2	HPA - Drain Supply Voltage
9,10	VC1, VC2	Tx/Rx Control Voltages
11, 13	G1L, G2L	LNA - Gate Supply Voltage
12, 14	D1L, D2L	LNA - Drain Supply Voltage

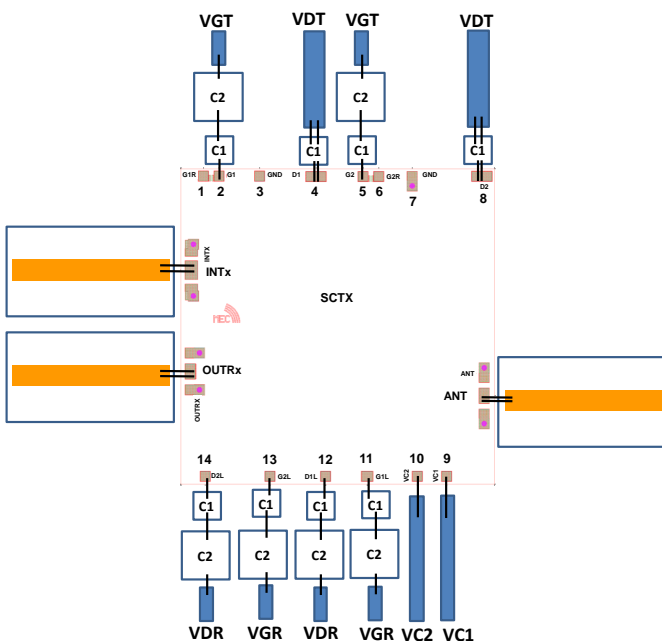

Bond Pad #	Connection	External Components
INTx, ANT and OUTRx	2 Bonding Wires $L_{\text{bond}} = 0.3\text{nH}$	
2, 5 <b>Vg - HPA</b>	$L_{\text{bond}} \leq 1\text{ nH}$	$C1 = 100\text{pF}/10\text{V}$ $C2 = 10\text{nF}/10\text{V}$
4, 8 <b>Vd - HPA</b>	$2 * L_{\text{bond}} \leq 1\text{ nH}$	$C1 = 100\text{pF}/50\text{V}$
11, 13 <b>Vg - LNA</b>	$L_{\text{bond}} \leq 1\text{ nH}$	$C1 = 100\text{pF}/10\text{V}$ $C2 = 10\text{nF}/10\text{V}$
12, 14 <b>Vd - LNA</b>	$L_{\text{bond}} \leq 1\text{ nH}$	$C1 = 100\text{pF}/25\text{V}$ $C2 = 10\text{nF}/25\text{V}$
9, 10 <b>VC1, VC2</b>	$L_{\text{bond}} \leq 1\text{ nH}$	No external components required (Internal Series Resistance: $R_s = 4\text{k}\Omega$ )



## X-Band GaN Single-Chip Transceiver Frontend

- Eutectic Die bond using AuSn (80/20) solder is recommended.
- Great care must be used for thermal dimensioning.
- The backside of the die is the Source (ground) contact.
- Thermosonic ball or wedge bonding are the preferred connection methods.
- Gold wire must be used for connections.

### Bias Procedure - Tx Mode

#### Bias-Up

1. Vg-HPA and Vg-LNA set to - 5 V.
2. VC1 set to 0V and VC2 set to -25V.
3. Vd-LNA set to 0V.
4. Vd-HPA set from 0V up to 30V.
5. Adjust Vg-HPA until quiescent Id is 280 mA (Vg = -2.9 V Typical).
6. Apply RF signal.

#### Bias-Down

1. Turn off RF signal.
2. Reduce Vg-HPA to -5 V (Id0  $\approx$  0 mA).
3. Set Vd-HPA to 0 V.
4. Turn off Vd-HPA and Vd-LNA.
5. Turn off Vg-HPA and Vg-LNA.
6. Turn off VC1 and VC2.

### Bias Procedure - Rx Mode

#### Bias-Up

1. Vg-LNA and Vg-HPA set to - 5 V
2. VC1 set to -25V and VC2 set to 0V.
3. Vd-HPA set to 0V.
4. Vd-LNA set from 0V up to 10V.
5. Adjust Vg-LNA until quiescent Id is 80 mA (Vg = -2.8 V Typical).
6. Apply RF signal.

#### Bias-Down

7. Turn off RF signal.
8. Reduce Vg-LNA to -5 V (Id0  $\approx$  0 mA).
9. Set Vd-LNA to 0 V.
10. Turn off Vd-LNA and Vd-HPA.
11. Turn off Vg-LNA and Vg-HPA.
12. Turn off VC1 and VC2.

### **Contact Information**

For additional technical Information and Requirements:

Email: [contact.mec@mec-mmic.com](mailto:contact.mec@mec-mmic.com)

Tel: +39 0516333403

For sales Information and Requirements:

Email: [sales@mec-mmic.com](mailto:sales@mec-mmic.com)

Tel: +39 0637511124

### **Notice**

The furnished information is believed to be reliable. However, performances and specifications contained herein are based on preliminary characterizations and then susceptible to possible variations. On the basis of customer requirements the product can be tested and characterized in specific operating conditions and, if needed, tuned to meet custom specifications.

The contents of this document are under the copyright of MEC srl. It is released by MEC srl on condition that it shall not be copied in whole, in part or otherwise reproduced (whether by photographic, reprographic, or any other method) and the contents thereof shall not be divulged to any person other than inside the company at which has been provided by MEC.